

RTV-304,CA/404,CA/504,CA/801,CA

BIG BORE TABLES, TOP MOUNTED MOTOR





The RTV,CA-Series rotary tables feature an extra large center bore with a top mounted servomotor. RTV,CA series tables utilize a powerful Dual Disc hydraulic clamping mechanism (pg. 74). RTV,CA series rotary tables are particularly suited for use on horizontal machining centers.



RTV-404,CA

Specifications

Dimensions = mm

Table Model	RTV-304,CA	RTV-404,CA	RTV-504,CA	RTV-801,CA	
Table diameter	350	450	550	800	
Center height	235	280	350	530	
Center bore	Nose Diameter	190H7	250H7	315H7	460H7
	Thru Diameter	160	209	270	420
Table T-slot width	14H7	14H7	18H7	18H7	
Guide block width	18h7			22h7	
Servo motor (Fanuc)*	Alpha 12i				
Maximum motor speed rpm	3,000				
Speed reduction ratio	1/90	1/90	1/120	1/360	
Maximum table speed rpm	33.3	33.3	25	8.3	
Inertia converted into motor shaft x 10 ⁻³ kg·m ²	2.70	4.05	6.01	4.35	
Clamp system**	Hydraulic				
Clamp torque @500psi Nm (ft. lbs.)	2,700 (1,990)	4,600 (3,390)	5,800 (4,275)	14,500 (10,687)	
Indexing accuracy arc sec.	±7.5				
Repeatability arc sec.	±2				
Net Weight kg (lbs.)	180 (396)	430 (946)	590 (1,298)	1,370 (3,014)	
Allowable wheel torque Nm (ft. lbs.)	1,370 (1,010)	2,630 (1,938)	4,200 (3,095)	7,840 (5,778)	
Allowable work inertia kg·m ²	10.0	20.0	30.0	120.0	
Allowable load when table clamped	 kg (lbs.) 300 (660) [500 (1,100)]	350 (770) [700 (1,540)]	500 (1,100) [1,000 (2,200)]	600 (1,320) [1,500 (3,300)]	
	 N (lbf) 29,400 (6,586)	45,000 (10,080)	54,000 (12,096)	64,400 (14,426)	
	 Nm (ft. lbs.) 2,700 (1,990)	4,600 (3,390)	5,800 (4,275)	14,500 (10,687)	
	 Nm (ft. lbs.) 3,626 (2,672)	8,000 (5,896)	15,132 (11,152)	27,000 (19,899)	

*Other motors & rpm available • Specifications subject to change without notice • ** Booster optional



3980 Webster Avenue Cincinnati, OH 45212 Phone: 513.531.2926 info@technitron.com

www.komprecision.com • info@komprecision.com

Dimensions

Drawings not to scale • Dimensions = mm

RTV-304,CA

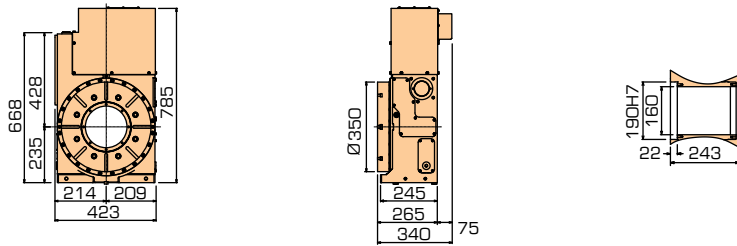

RTV-404,CA

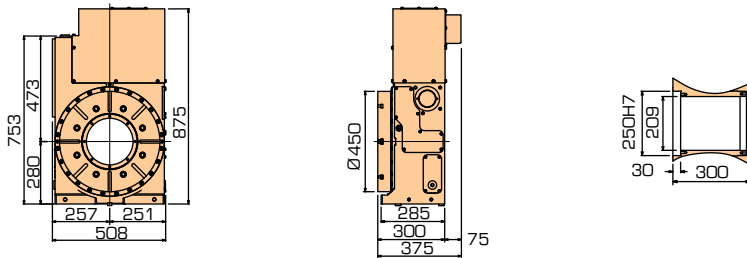

RTV-504,CA

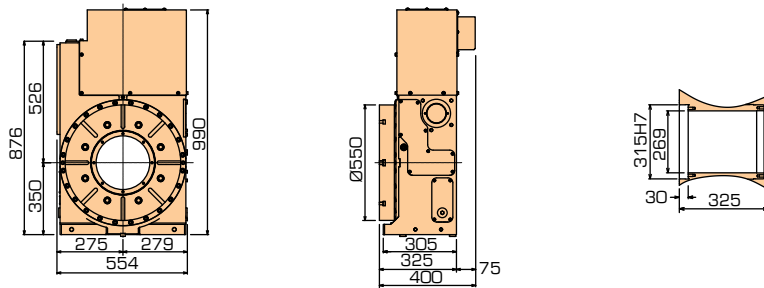

RTV-801,CA

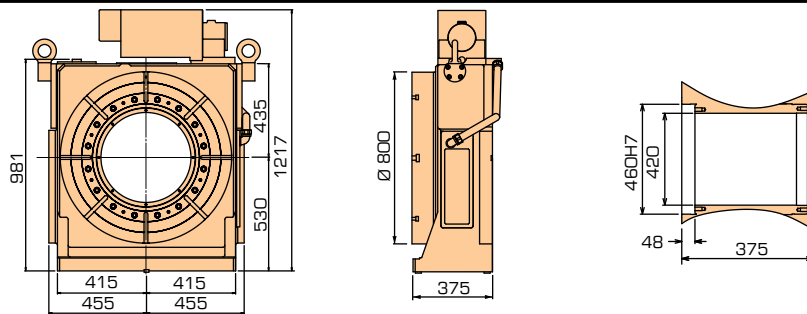

The dimensions above are for tables with a FANUC servo motor. Other motors available (dimensions may increase).

RTV-404,CA
Optional Swivel Box



RTV Big Bore Chucks
Contact Koma for custom
big bore chuck information



OPTIONS • ACCESSORIES

Table Model	Faceplate	TPC NC Controller	Big Bore Chucks & Collets	Tailstocks Support Spindles	PVC or Steel Braided Cables	Scales	Rotary Joint	Air/Hydraulic Booster
RTV-304,CA	Standard	TPC3 Series	Yes	Yes	Yes	Yes	Yes	Yes
RTV-404,CA	Standard	TPC3 Series	Yes	Yes	Yes	Yes	Yes	Yes
RTV-504,CA	Standard	TPC3 Series	Yes	Yes	Yes	Yes	Yes	Yes
RTV-801,CA	Standard	TPC3 Series	Yes	Yes	Yes	Yes	Yes	Yes